

**A** / **B**

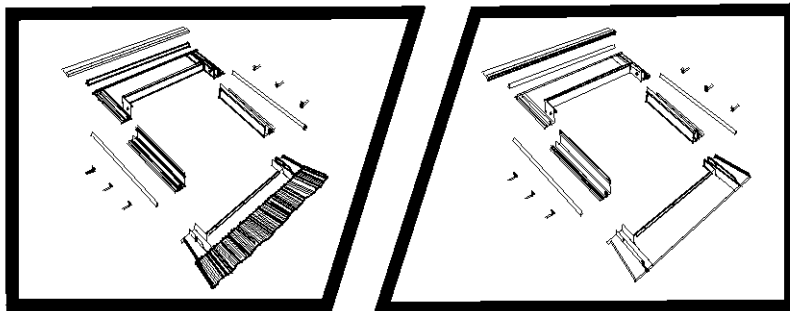

**C** / **D**

A

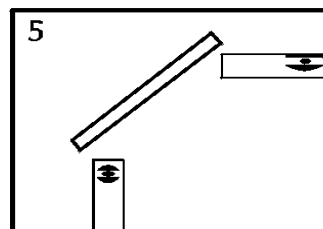
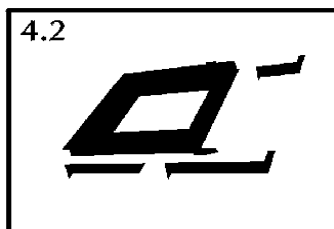
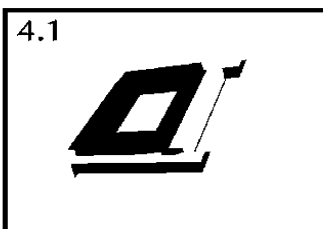
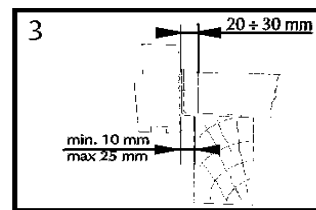
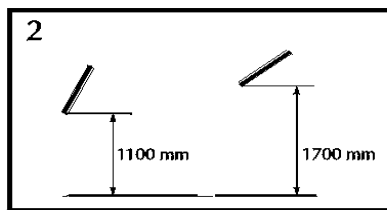
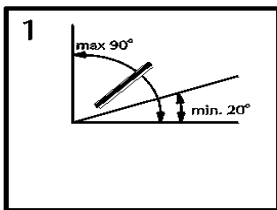
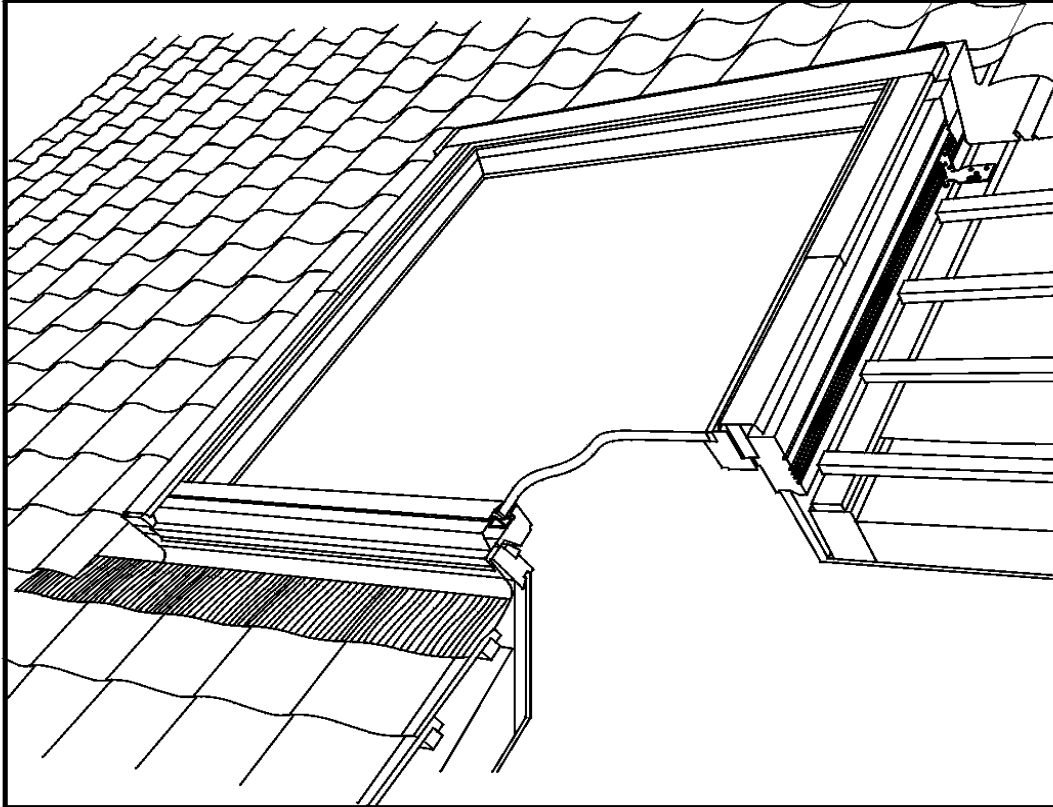

**A**

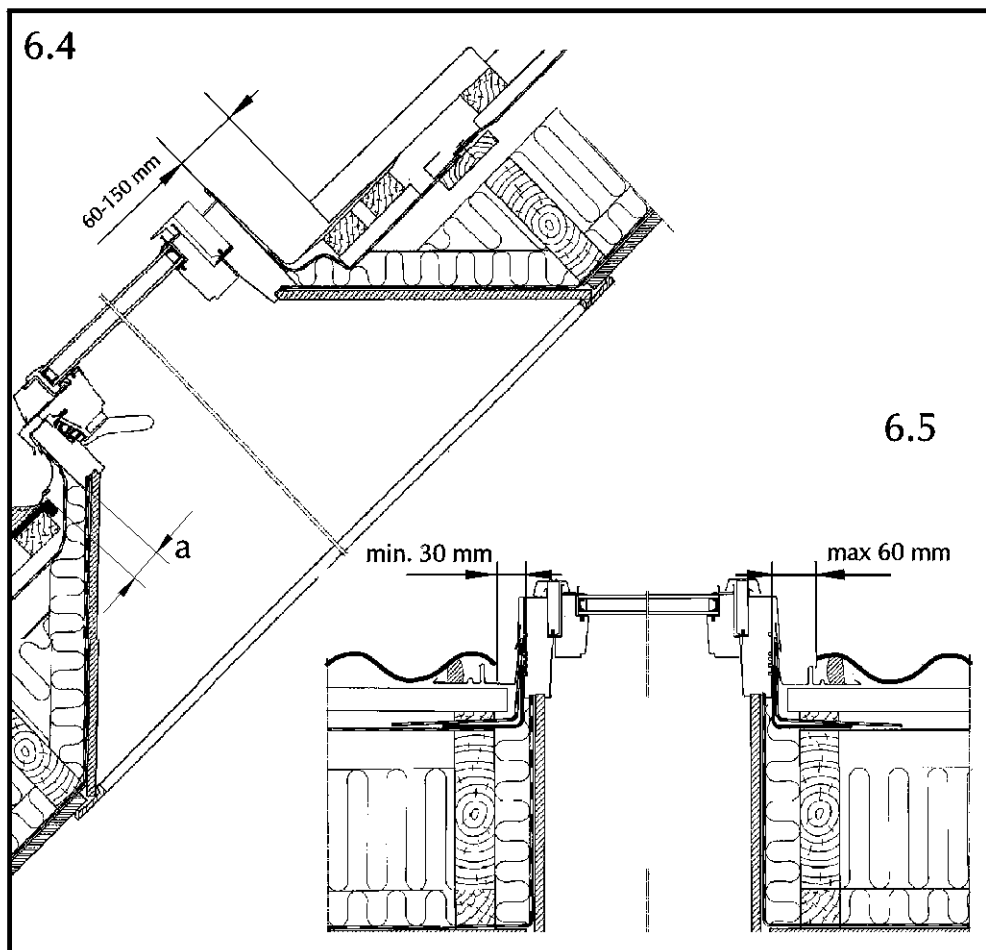
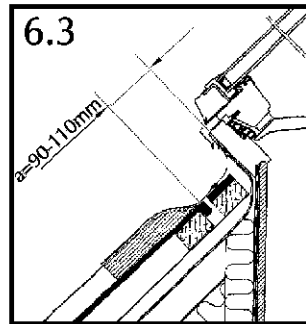
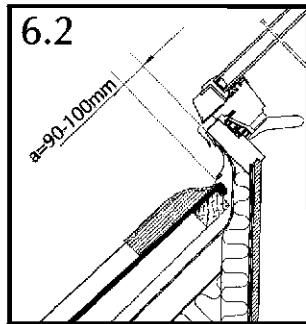
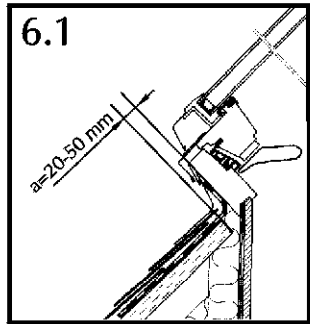

**A**

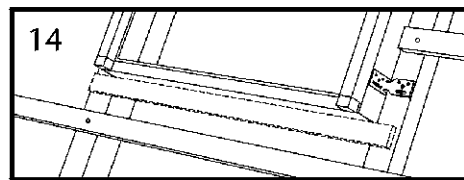
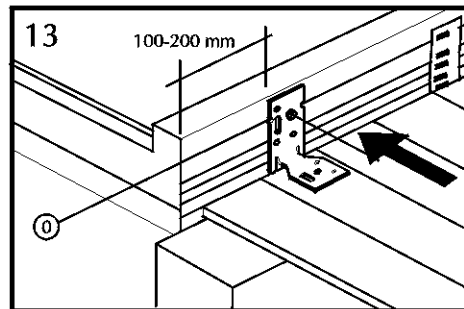
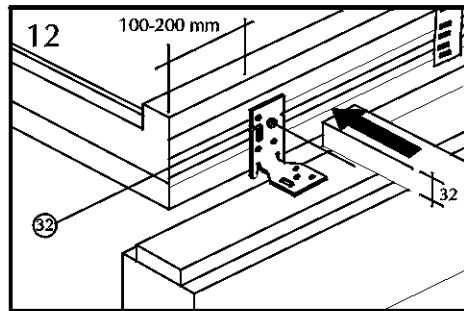
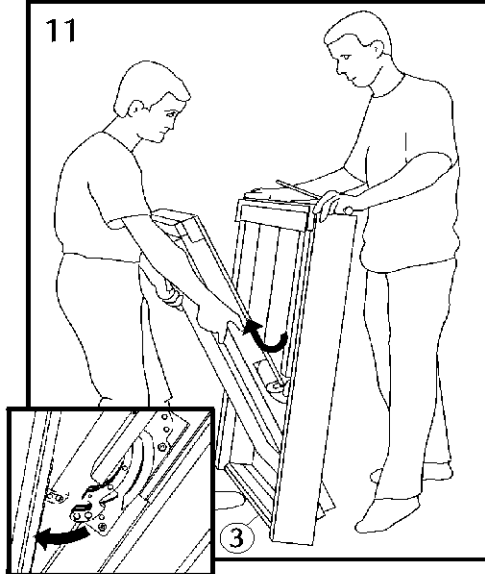
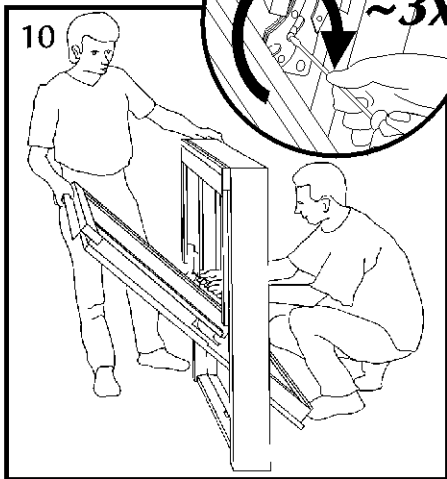
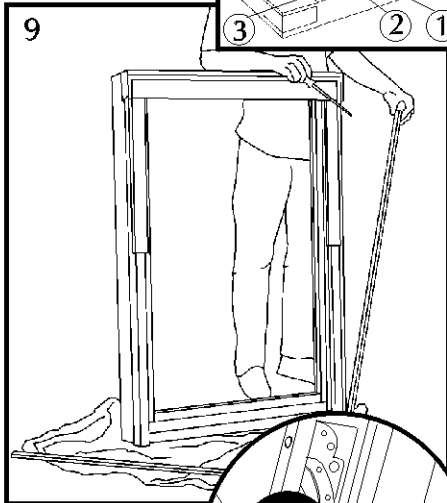
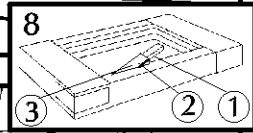
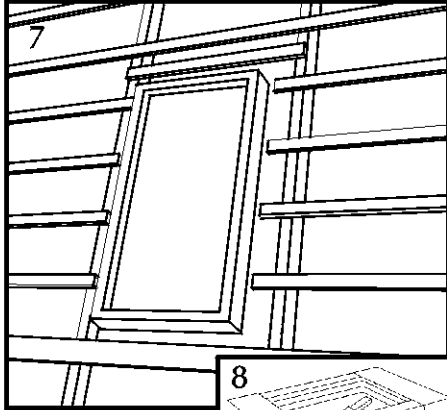

**A**

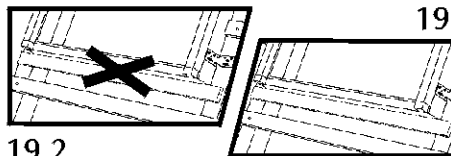
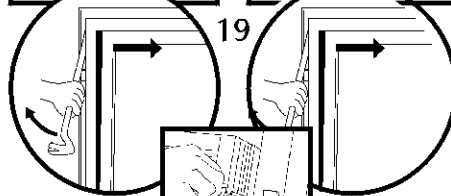
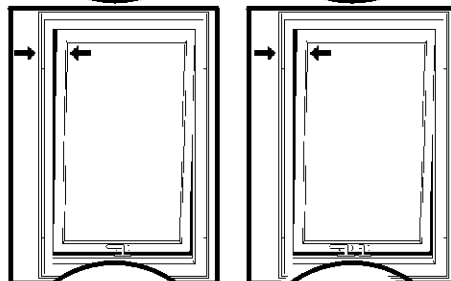
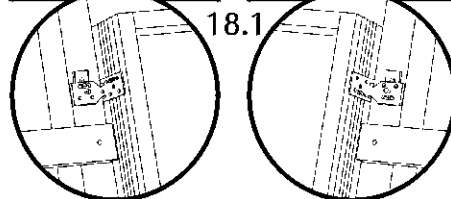
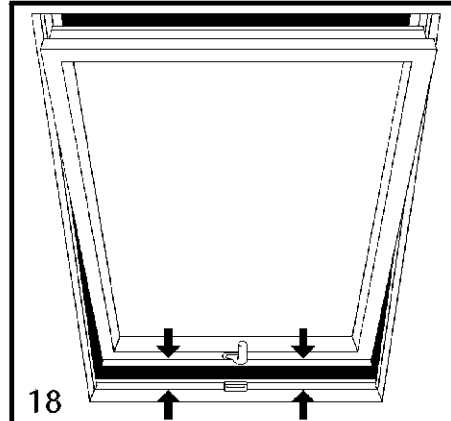
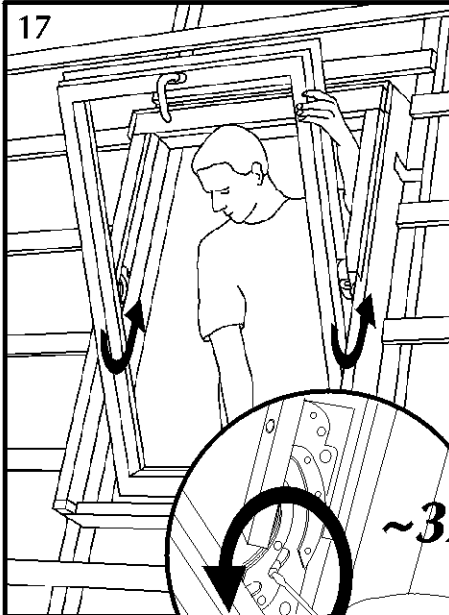
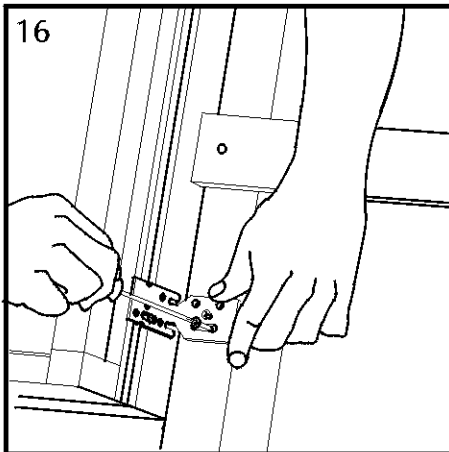
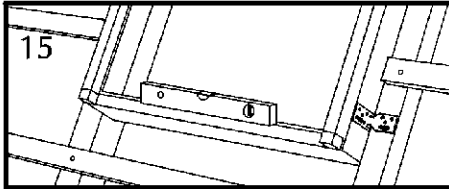

**A**

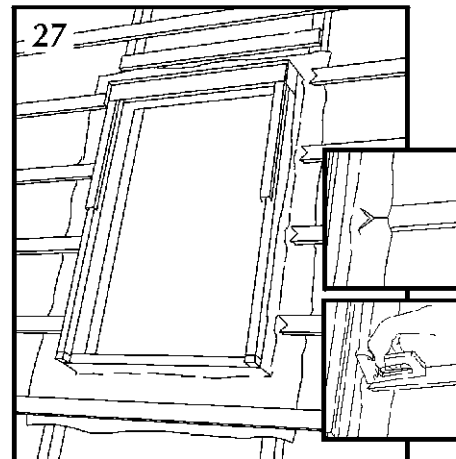
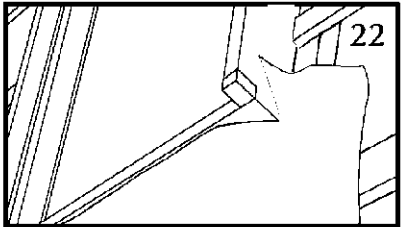
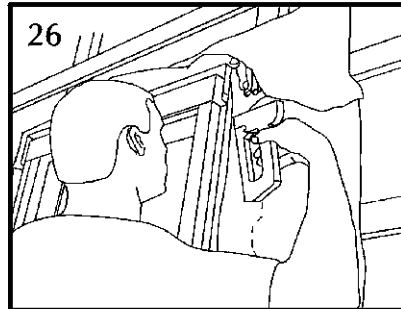
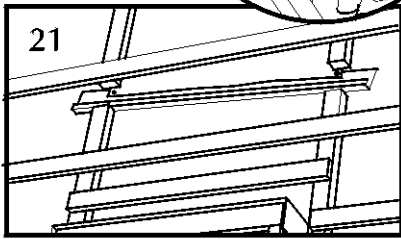
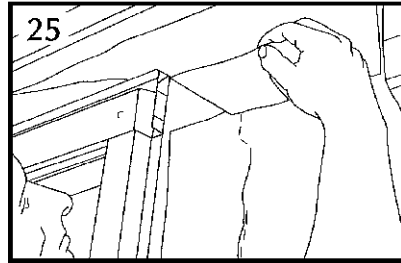
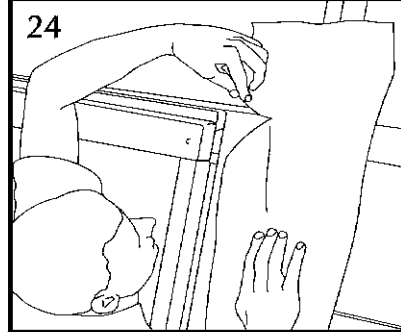
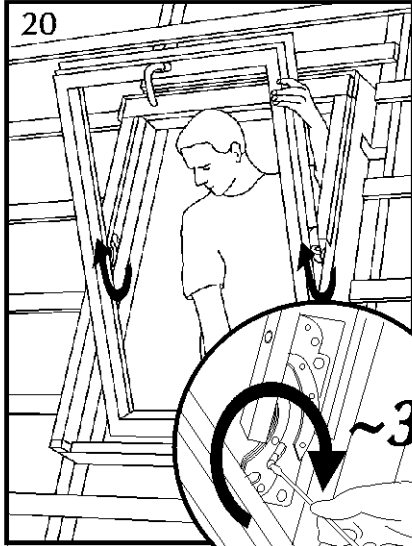

**B**

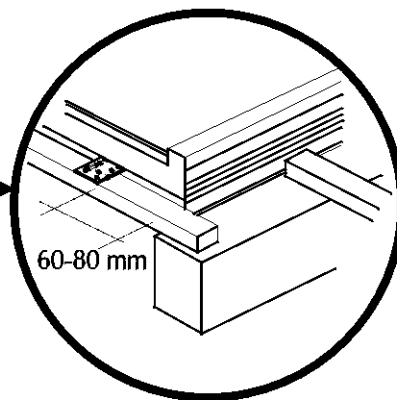
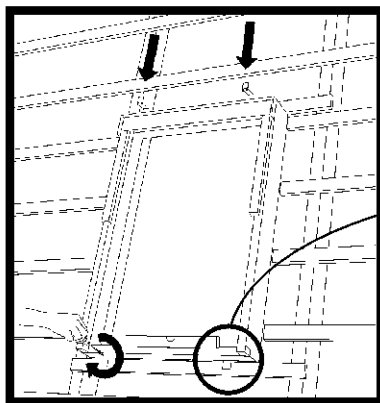
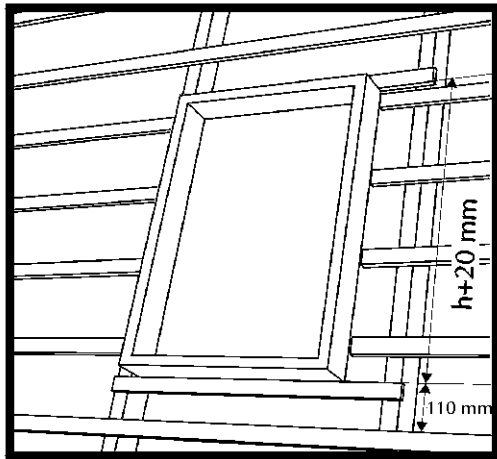
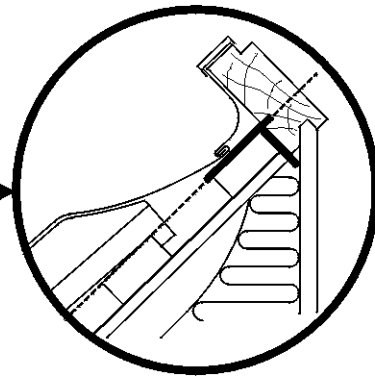
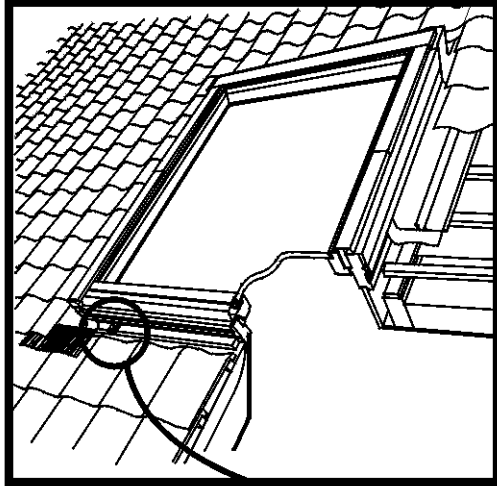

# C

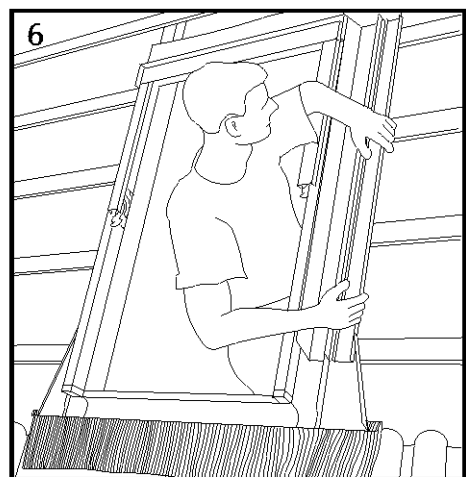
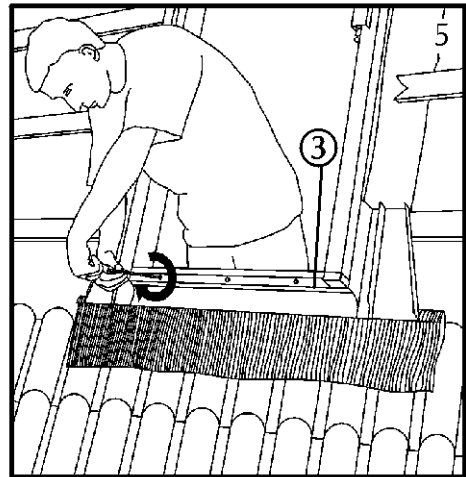
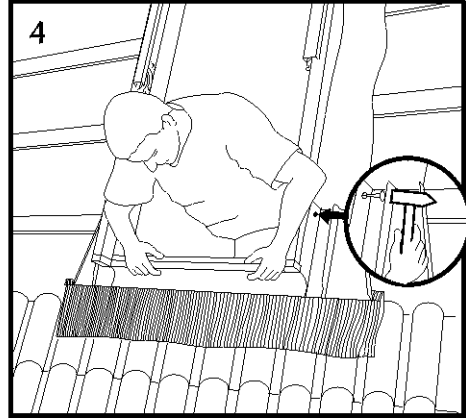
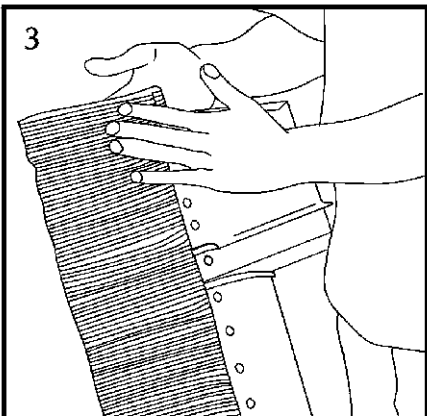
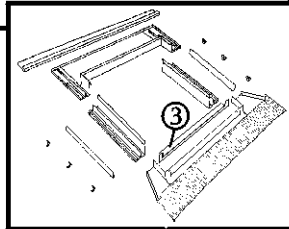
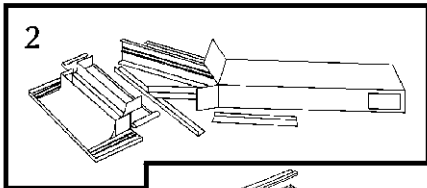
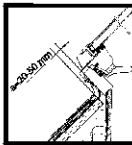
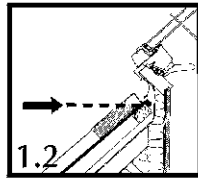
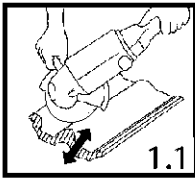
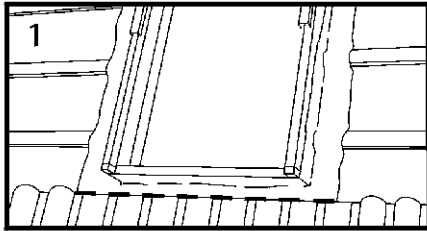

C

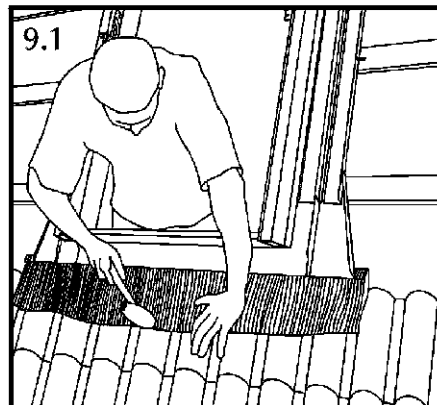
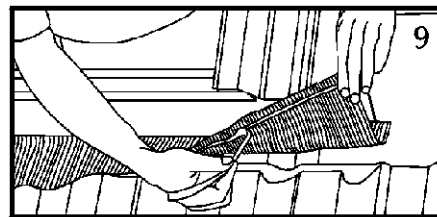
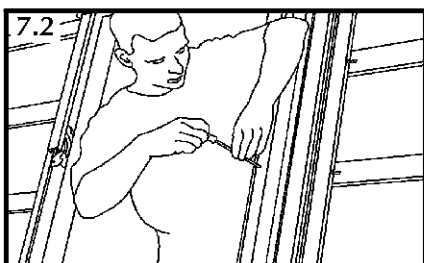
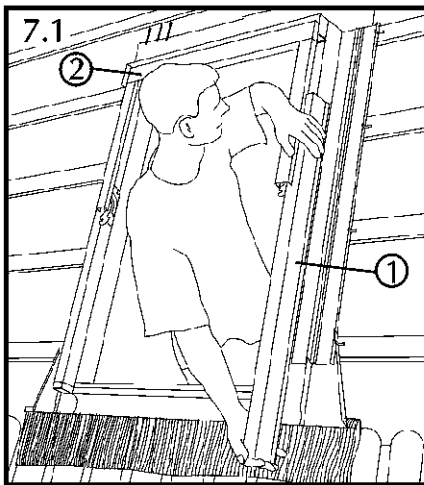
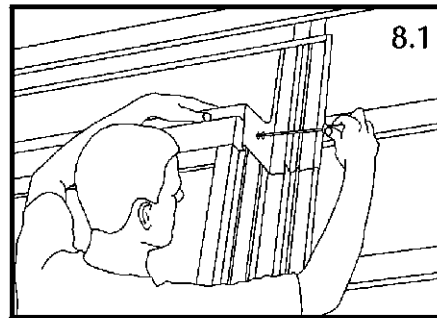
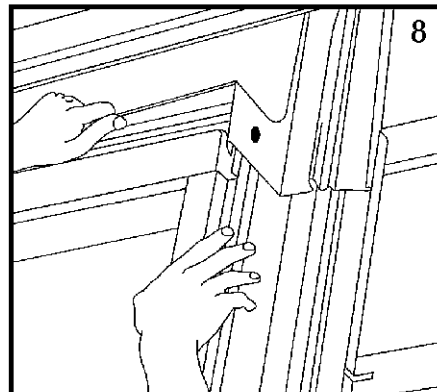
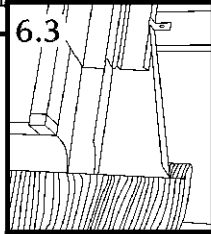
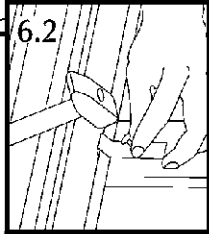
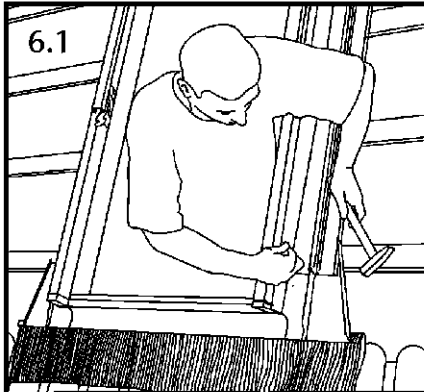

C

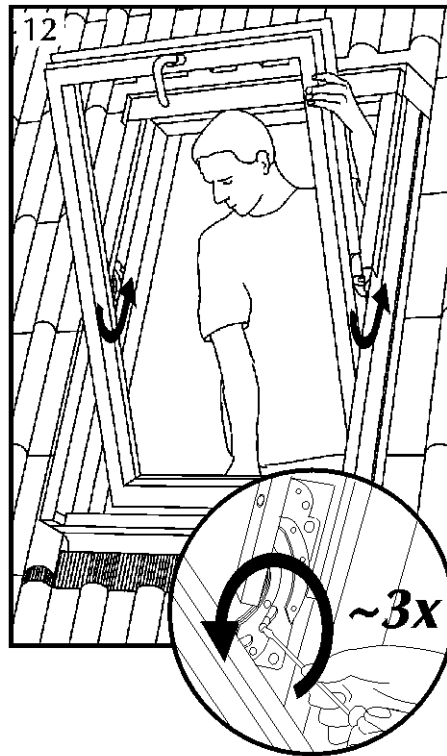
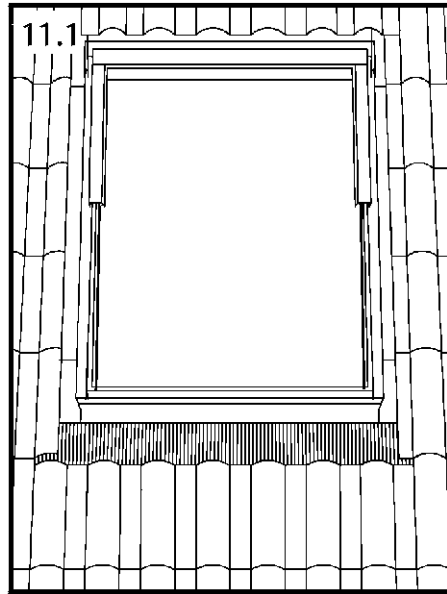
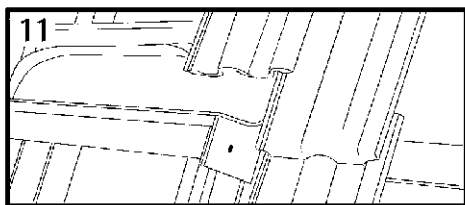
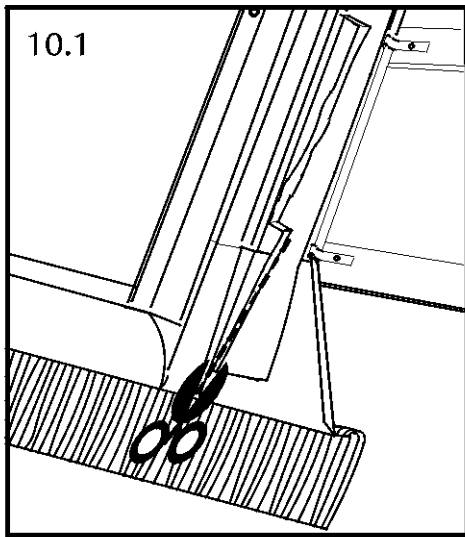
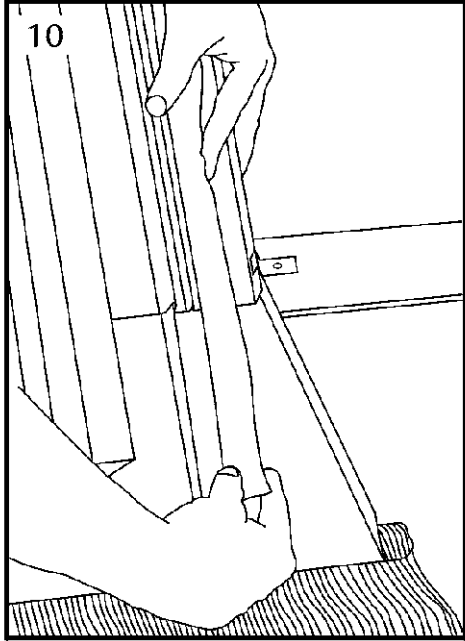

**D**

